

## LEGENDARY SLATE

DISTRIBUTOR \_\_\_\_\_ DATE \_\_\_\_\_

CONTRACTOR \_\_\_\_\_ COLOR \_\_\_\_\_

CUSTOMER NAME \_\_\_\_\_  STD. WT.  ULTRALITE  SUPER DUTY

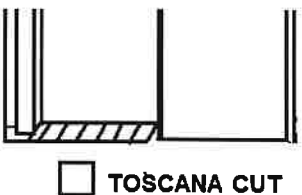
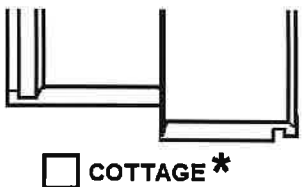
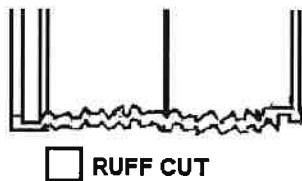
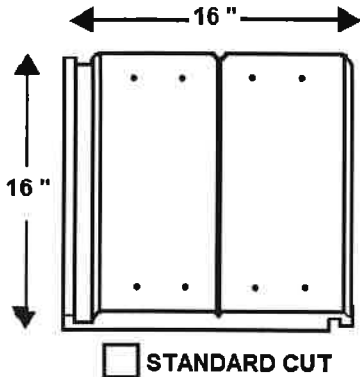

- ### TRIM OPTIONS
- RUFF-CUT
  - 70% SWIRL BRUSHED
  - 70% VINTAGE RUFF-MOSS

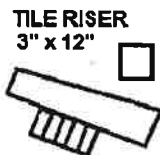

VENTILLATED BATTEN  
(PAINTED BLACK)  
1.5" x 4 FEET

\* ADD 10% MORE TILE

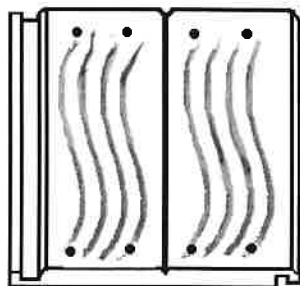
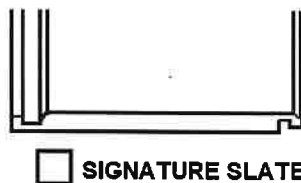

- 70% RANDOM SWIRL BRUSHED
- 100% STRAIGHT BRUSHED
- 50% STRAIGHT BRUSH (ONE SIDE ONLY)

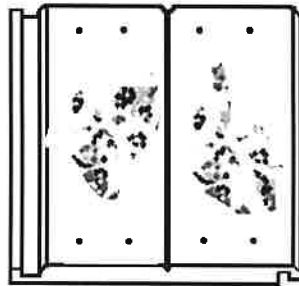

- 70% VINTAGE RUFF MOSS

### SLATE TRIM UNITS

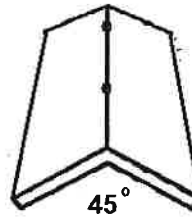

- V STYLE HIP / RIDGE  
5/12 - 8/12 PITCH

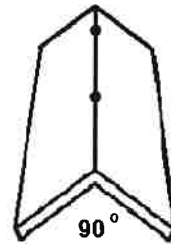

- STEEP RIDGE  
9/12 - STEEPER PITCH

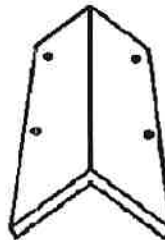

- UNIVERSAL RAKE

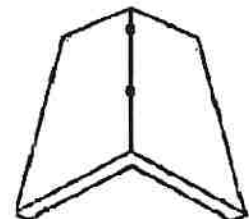

- LOW PITCH  
2/12 - 4/12

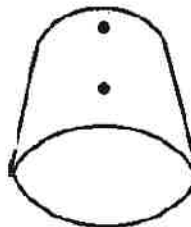

- USR HIP STARTERS

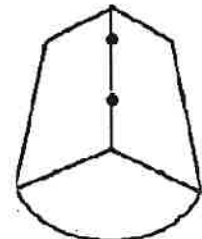

- V STYLE HIP STARTERS

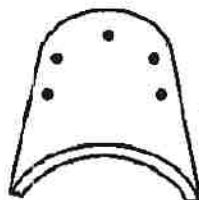

- UNIVERSAL RAKE

- RAKE METAL OPTION

- SOLID GABLE TILES

- VENTILLATED BATTENS FOR FIELD TILE (1X4')

- 2.5" NAILS RINGSHANKS

ORDER WILL BE MANUFACTURED AS CHOSEN.  
 NO RETURNS ON TILE OR ACCESSORIES.

CUSTOMER ACCEPTANCE \_\_\_\_\_

SIGNATURE \_\_\_\_\_